

SERIES: PSE-3000 | DESCRIPTION: AC-DC HOT-SWAP POWER SUPPLY
FEATURES

- up to 3000 W continuous power
- 80 PLUS Platinum Efficiency
- PoE output isolation; (1500 Vrms to ground)
- high power density - 33.48 W/in³
- PMBus™ communication for monitoring & control
- dual fan forced cooling with speed control
- front to back (-F) and back to front (-B) airflow versions
- power factor correction
- 3.3 Vdc (2A) standby voltage
- redundant (N+1) operation
- blind mate connections for hot-swap
- constant power (CP) mode
- harmonic correction to EN61000-3-2, Class A
- DROOP current sharing
- single I/O connector for AC input, DC output & signals
- remote on/off control
- power good signal
- optional 19" four slot power shelf

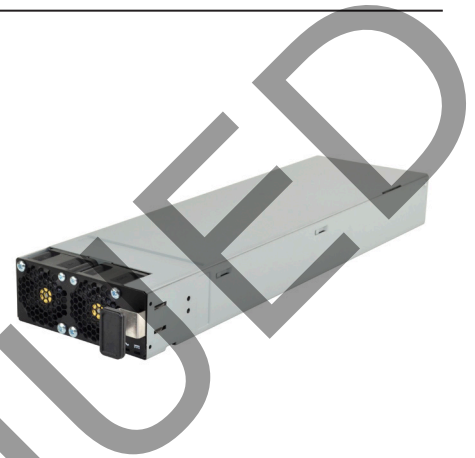

| MODEL | output voltage | output current | output power ^{2,3} | ripple and noise ¹ | efficiency ⁴ |
|---------------|----------------|----------------|-----------------------------|-------------------------------|-------------------------|
| | (Vdc) | max (A) | max (W) | max (mVp-p) | typ (%) |
| PSE-3000-48-F | 48 | 62.5 | 3000 | 480 | 94 |
| PSE-3000-48-B | 48 | 62.5 | 3000 | 480 | 94 |
| PSE-3000-54-F | 54 | 55.5 | 3000 | 540 | 94 |
| PSE-3000-54-B | 54 | 55.5 | 3000 | 540 | 94 |

Notes:

1. Measured at 20 MHz bandwidth at an oscilloscope jack on the output with 0.1 μ F ceramic and 10 μ F aluminum electrolytic capacitors.
2. At 90~180 Vac input, maximum of 1500 W.
3. At 180~264 Vac input, maximum of 3000 W.
4. At 230 Vac input, 3000 W. Meets 80 PLUS platinum efficiency requirements.
5. All specifications measured at: Ta=25°C and 220 Vac input voltage unless otherwise specified.

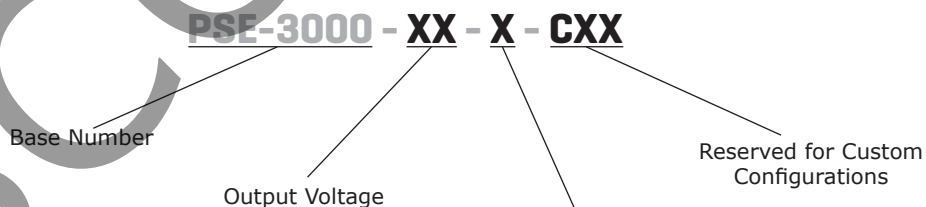
PART NUMBER KEY

Airflow Direction:

F = AC input connector to DC output connector
B = DC output connector to AC input connector

INPUT

| parameter | conditions/description | min | typ | max | units |
|-------------------------|--|------|----------|--------------|--------------|
| voltage | | 90 | | 264 | Vac |
| frequency | | 47 | | 63 | Hz |
| current | at 90 Vac, 1500 W at 180 Vac, full load | | | 20.2 18.5 | Arms Arms |
| inrush current | at 115 Vac, cold start at 230 Vac, cold start | | 20 40 | | A A |
| leakage current | | | | 1.5 | mArms |
| power factor correction | at 230 Vac, full load | 0.99 | | | |

OUTPUT - V1 (MAIN OUTPUT)

| parameter | conditions/description | min | typ | max | units |
|--------------------------------|---|-----|-----|--------|-------|
| line regulation | | | ±3 | | % |
| load regulation | | | ±3 | | % |
| load capacitance | | | | 30,000 | µF |
| transient response | 50% step load, 1A/µs slew rate, recovery to 1% within 1 ms | | | 3 | % |
| start-up time | | | | 5 | s |
| hold-up time | at 230 Vac, full load | 12 | | | ms |
| remote sense | between both output terminals | | 0.5 | | V |
| current share accuracy (Droop) | over 25% to 100% load | | ±10 | | % |
| LED indicator | AC OK: "green" to indicate AC above the lower limit that is required to sustain normal operation DC OK: "green" to indicate module in normal operating condition | | | | |

OUTPUT - V2 (STANDBY OUTPUT)

| parameter | conditions/description | min | typ | max | units |
|-------------------------------|---|-----|-----|------|-------|
| output voltage | | | 3.3 | | Vdc |
| output current | | 0 | | 2 | A |
| ripple and noise ¹ | | | | 33 | mVp-p |
| line regulation | | | ±5 | | % |
| load regulation | | | ±5 | | % |
| load capacitance | | | | 1000 | µF |
| transient response | 50% step load, 1A/µs slew rate, recovery to 1% within 1 ms | | | 3 | % |
| start-up time | | | | 5 | s |

Notes: 1. Measured at 20 MHz bandwidth at an oscilloscope jack on the output with 0.1 µF ceramic and 10 µF aluminum electrolytic capacitors.

PROTECTIONS

| parameter | conditions/description | min | typ | max | units |
|-----------------------------|--|-----|-----|-------------|----------|
| over voltage protection | V1: latch off V2: latch off | 110 | | 60 120 | Vdc % |
| over current protection | V1: constant current inception V2: hiccup | | | 62.5 2.6 | A A |
| over temperature protection | at full load, auto recovery | | 55 | | °C |

SAFETY & COMPLIANCE

| parameter | conditions/description | min | typ | max | units |
|--|--|---------|-----|-----|-------|
| insulation safety rating / test voltage | input to output, reinforced | 3,000 | | | Vrms |
| | input to chassis, basic | 1,500 | | | Vrms |
| isolation voltage | output to output | 1,500 | | | Vrms |
| | output to chassis | 1,500 | | | Vrms |
| | signals to chassis/ground | 1,500 | | | Vdc |
| | V2 to chassis/ground | 100 | | | Vdc |
| grounding | The main output V1 is "floating" and not referenced to chassis/ground. The output control and status signals are referenced to the V2 output return connection. | | | | |
| safety approvals | EN60950-1:2006+A11+A1+A12, IEC60950-1:2005+Amd 1, CAN/CSA-C22.2 No.60950-1-07+A1:2011, UL 60950-1:2007 R12.11(NRTL Route), EEC/93/68/LVD, 2006/95/EC LVD | | | | |
| conducted emissions | FCC 15 Sub Part B, EN55022, Class A: 3dB margin tested with resistive load | | | | |
| radiated emissions | FCC 15 Sub Part B, EN55022, Class A: 3dB margin tested with resistive load | | | | |
| harmonic compliance | EN/IEC 61000-3-2:2009, Class A Harmonic Limits Compliance Level: 230 Vac line voltage, 100% output load | | | | |
| flicker | EN/IEC 61000-3-3:2009 limits as specified in the standard: flicker and voltage fluctuations | | | | |
| electrostatic discharge | EN/IEC 61000-4-2, ±8 kV operational air discharge, ±8 kV contact discharge: all parameters to remain within limits, test set up to be defined | | | | |
| RF electro-magnetic field. amplitude modulated | EN/IEC 61000-4-3 80~1000 MHz, 10V/m, 80% AM Modulation (1 kHz): all parameters to remain within limits, test set up to be defined | | | | |
| immunity to fast transients | EN/IEC 61000-4-4 Power lines: ±2 kV: all parameters to remain within limits, test set up to be defined | | | | |
| surges (mains) | EN/IEC 61000-4-5 ±1 kV line to line, ±2 kV line to earth, Criteria A: all parameters to remain within limits, test set up to be defined | | | | |
| RF continuous conducted | EN/IEC 61000-4-6 150 kHz~80 MHz 3Vrms 80% AM (1 kHz), Criteria A: all parameters to remain within limits, test set up to be defined | | | | |
| voltage dips/interruptions | IEC 61000-4-11 30% reduction for 10 ms, 60% reduction for 100 ms: Reset is permitted must be selfrecovering. Additionally, the PSU shall not latch up during any brownout condition. | | | | |
| MTBF | as per Telcordia SR-332, Issue 2, Sept 2006 component stress method at Ta=25°C | 916,000 | | | hours |
| RoHS | 2011/65/EU | | | | |
| WEEE | 2012/19/EU | | | | |

ENVIRONMENTAL

| parameter | conditions/description | min | typ | max | units |
|-----------------------|------------------------|-----|-----|-----|-------|
| operating temperature | full load, no derating | 0 | | 50 | °C |
| storage temperature | non-condensing | -40 | | 70 | °C |
| operating humidity | non-condensing | 10 | | 90 | % |
| storage humidity | | 5 | | 90 | % |

ENVIRONMENTAL (CONTINUED)

| parameter | conditions/description | min | typ | max | units |
|------------------------------|--|-----|-----|-----|---------|
| acoustic | ISO 7779-1999 | | | 60 | dB LpAm |
| cold ¹ | IEC 68 Part 2 – 1: at -10°C minimum for 4 hours | | | | |
| dry heat | IEC 68 Part 2 – 2: at 50°C minimum for 4 hours | | | | |
| damp heat, cyclic | IEC 68 Part 2 – 30: at 20~45°C, 30~95 %RH | | | | |
| low air pressure (operating) | IEC 68 Part 2 – 13: at 10,000 feet, 697 mbar | | | | |
| vibration (sinusoidal) | IEC 68 Part 2 – 6: at 10~58 Hz, 0.075 mm; 58~500 Hz, 10 m/s ² , 1 octave/minute, 10 cycles/ main axis | | 1 | | G |
| shock | IEC 68 Part 2 – 27: at 300 m/s ² , 11 ms, half sine wave 3 shocks/main axis | | 30 | | G |
| bump | IEC 68 Part 2 – 29: at 150 m/s ² , 6 ms, half sine wave 900 bumps/main axis | | 15 | | G |

Notes: 1. The module shall start up at -10°C, however it is not required that the full specification is achieved until the operational internal temperature has risen to 0°C.

MECHANICAL

| parameter | conditions/description | min | typ | max | units |
|-----------------------|--|-----|------|-----|--------|
| dimensions | 14.00 x 4.00 x 1.60 (355.6 x 101.6 x 40.6 mm) | | | | inches |
| weight | | | 2.01 | | kg |
| cooling / airflow | integral fans | | | | |
| material flammability | UL 94V-0 | | | | |
| AC input | IEC320/C14 | | | | |
| DC output | FCI PwrBlade P/N 51939-661LF mates with FCI P/N 51915-351LF | | | | |

MECHANICAL DRAWING

units: inches [mm]
tolerance:
X.XX ±0.02 [0.50]
X.XXX ±0.010 [0.25]

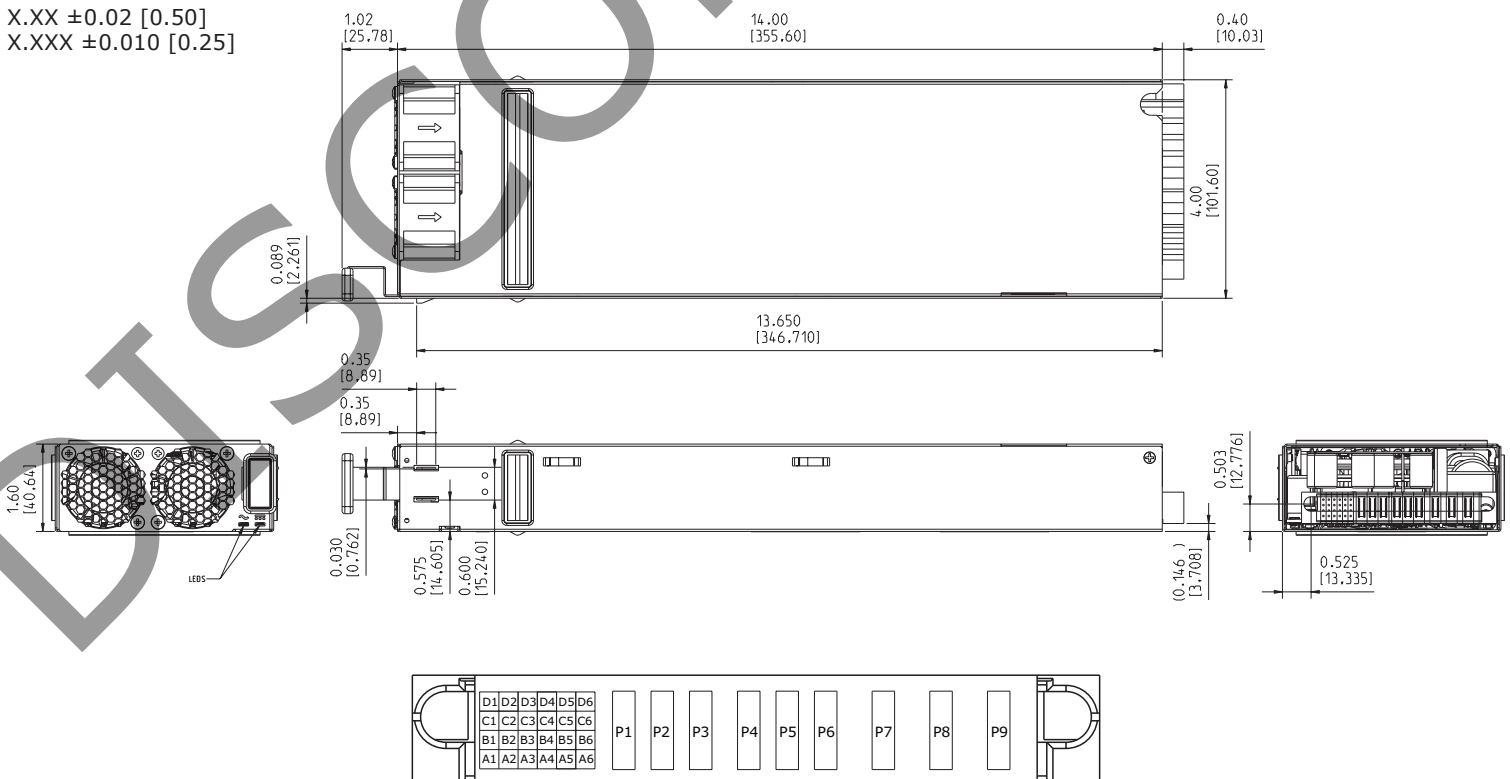

DC PIN ASSIGNMENTS

| PIN | | FUNCTION | DESCRIPTION | HIGH / LOW LEVEL | Imax | |
|-----------------------|----|------------------------------|---|------------------|-------|--------|
| P1, P2, P3 | | V (-VE/return) | V1 (-VE) output terminal | | | |
| P4, P5, P6 | | V (+VE) | V1 (+VE) output terminal | | | |
| P7 | | earth/chassis ground | protective/safety earth | | | |
| P8 | | neutral | neutral or AC line#2 | | | |
| P9 | | line | hot/AC line#1 | | | |
| signal pin column "1" | A1 | I ² C address A0 | I ² C address - LSB | | | |
| | B1 | I ² C address A1 | I ² C address bit | | | |
| | C1 | I ² C address A2 | I ² C address - MSB | | | |
| | D1 | REMOTE_ON_L | internal pull up to 3.3 V | | | 3.3 mA |
| | | | signal pin status | output status | | |
| | | | open circuit | "off" | | |
| logic "1" | | | "off" | | | |
| | | logic "0" | "on" | | | |
| signal pin column "2" | A2 | DC_OK_L | "L" to indicate DC output is within regulation, there is no internal pull up resistor and it should be provided externally to support VCEO ≤ 20 Vdc, Ic ≤ 5 mA dc | >2.1 V <0.4 V | -5 mA | |
| | B2 | AC_OK_L | "L" to indicate AC above lower limit that is required for sustain normal operation, there is no internal pull up resistor and it should be provided externally to support VCEO ≤ 20 Vdc, Ic ≤ 5 mA dc | >2.1 V <0.4 V | -5 mA | |
| | C2 | PS_PRESENT_L | detects presence of power supply, "low" when inserted, host system to provide pull up resistor capable of sourcing 5 mA | >2.1 V <0.4 V | -5 mA | |
| | D2 | Vstandby (+VE) | V2 (+VE) output terminal | | | |
| signal pin column "3" | A3 | I ² C/SMBus clock | external 3.32 kΩ pull-up needed to 3.3 V | | -3 mA | |
| | B3 | I ² C/SMBus data | external 3.32 kΩ pull-up needed to 3.3 V | | -3 mA | |
| | C3 | SMBALERT | communications (SMBus) alert | >2.1 V <0.4 V | -5 mA | |
| | D3 | Vstandby (-VE) | V2 (-VE) output terminal | | | |
| signal pin column "4" | A4 | n/a | reserved | | | |
| | B4 | n/a | reserved | | | |
| | C4 | OTP_OK_L | temperature "OK" signal | >2.1 V <0.4 V | -5 mA | |
| | D4 | n/a | reserved | | | |
| signal pin column "5" | A5 | Spare/Vpgm | analog VPGM signal | | | |
| | B5 | n/a | reserved | | | |
| | C5 | n/a | reserved | | | |
| | D5 | n/a | reserved | | | |
| signal pin column "6" | A6 | V1 -VE sense | V1 negative sense connection | | | |
| | B6 | Ishare | V1 current share option | | | |
| | C6 | n/a | reserved | | | |
| | D6 | V1 +VE sense | V1 positive sense connection | | | |

APPLICATION NOTES

Digital Communication Feature Set

The default method of digital communication shall utilize I²C hardware capable of operation at a minimum of 100 kHz clock (SCL) frequency. A mandatory feature of this module is that should either the module be disconnected from the incoming AC source (inserted in to a slot in an unpowered state); the module input fuse(s) fail; or the internal auxiliary supply (which derives the VCC of the I²C equipped device) fail, then any line associated with the I²C bus (SCL; SDA) should be disconnected (effectively tri-stated) from the I²C bus to prevent erroneous operation that may result from this unpowered condition. All I²C lines shall be "clean" and free from excessive spikes and common mode noise and comply with the requirements of the generic standard which defines I²C logic levels.

The I²C hardware should conform to the requirements of the NXP (formerly Philips Semiconductor) Standard: UM10204 I²C Bus Specification and User Manual; Rev 0.3; 19 June 2007.

The rectifier shall be capable of processing commands to monitor & control the rectifier via the digital bus by use of the following protocols:

- CUI's "standard" protocol – this shall be considered the "default" that shall be offered as a standard.
- The PMBus™ (Power Management Bus) Protocol – this shall be considered the "optional" offering.

I²C "Standard" Feature

The following features will be offered as "standard" by the base product:

Vital Product Data (VPD)

This feature shall provide write-protected Vital Product Data (VPD) which shall include the following:

- Revision level
- CUI Date Code and origin of manufacture
- CUI Serial number (from the product label) is the last 5 or 6 maximum numbers, and is padded with zeros to fit the PMBus™ variable as 8 bytes total

Slave Addresses

The product's 7-bit I²C slave address is formed by determining the logic state of the address pins A0, A1 and A2. A pull-up resistor shall be supplied within the product for each address pin. The values of A0, A1 and A2 are set in the backplane of the system. Thus the device can be set to respond to all 7-bit addresses in the range from binary 1011 000 to 1011 111.

The address pins shall be read once the micro-controllers have been initialized. To prevent hot swapping from latching the slave address to a specific slot in the enclosure, the software shall continuously read and update at an interval of 1 s the slave address accordingly.

| Bit 7 | Bit 6 | Bit 5 | Bit 4 | Bit 3 | Bit 2 | Bit 1 | Bit 0 |
|-------|-------|-------|-------|-------|-------|-------|-------|
| 1 | 0 | 1 | 1 | A2 | A1 | A0 | R/W |

APPLICATION NOTES (CONTINUED)

Digital Interface

The product is provided with a digital communications interface that is based upon a subset of the SMBus™ & PMBus™ Protocols.

The communication interface is a Two Wire Interface (TWI) using devices hardware compatible with I²C.

The interface is based upon the I²C Protocol developed by Philips Semiconductors (now NXP). Reference to the "I²C Bus Specification and User Manual" UM10204 Rev.03 – 19 June 2007 is recommended.

General Information

Refer to the PMBus™/SMBus specification for details on read/write operations when dealing with Byte, Word or Block process calls. Packet Error Correction (PEC) and Address Resolution Protocol (ARP) are not supported.

If the PMBus™ master tries to read more bytes than the length of the data selected by the command code, the additional bytes will be sent as 0xFF.

The PMBus™ slave device may apply clock stretching by holding the clock line (SCL) low after a command to indicate that it is busy processing data. A master device on the PMBus™ bus may attempt to continue with the communications but must first wait until the clock line is released. Clock stretching times will vary depending on the data being processed and/or if there are any higher priority events occur during the response but shall not exceed 25 ms.

APPLICATION NOTES (CONTINUED)

PMBus™ COMMAND SUBSET

The following is subset of commands (extracted from the "PMBus™ Power System Management Protocol Specification; Part II Command Language; Rev 1.2, 6 September 2010") and apply on a per module basis, (although certain commands could be applied "globally"). For a full definition of the individual command refer to the above referenced PMBus™ specification.

| Opcode (HEX) | Command Name | No. of Bytes | Type | Read / Write | Command Description |
|--------------|--------------------|--------------|-------|--------------|---|
| 01 | OPERATION | 1 | Byte | W | The OPERATION command is used to turn the unit on & off in conjunction with the CONTROL (short; last make, first make pin). |
| 03 | CLEAR_FAULTS | 0 | N/A | W | Clear fault data latched at STATUS_WORD |
| 19 | CAPABILITY | 1 | Byte | R | Follows PMBus™ spec. |
| 78 | STATUS_BYTE | 1 | Byte | R | Lower byte returned from the STATUS_WORD |
| 79 | STATUS_WORD | 2 | Word | R | The command returns two bytes of data relating to the unit fault condition. |
| 88 | READ_VIN | 2 | Word | R | Provides the measured input voltage of the power module. (Divide decimal value by 100) |
| 89 | READ_IIN | 2 | Word | R | Provides the measured input current of the power module. (Divide decimal value by 100) |
| 8B | READ_VOUT | 2 | Word | R | Provides the measured output voltage of the power module. (Divide decimal value by 100) |
| 8C | READ_IOUT | 2 | Word | R | Provides the measured output current of the power module. (Divide decimal value by 100) |
| 8D | READ_TEMPERATURE_1 | 2 | Word | R | This command shall return the prevailing internal ambient of the power module, in degrees Celsius. |
| 8E | READ_TEMPERATURE_2 | 2 | Word | R | This command shall return a select component temperature used by the power module, in degrees Celsius. |
| 8F | READ_TEMPERATURE_3 | 2 | Word | R | This command shall return a select component temperature used by the power module, in degrees Celsius. |
| 90 | READ_FAN_SPEED_1 | 2 | Word | R | Provides the measured fan speed (RPM) in the power module. |
| 91 | READ_FAN_SPEED_2 | 2 | Word | R | Provides the measured fan speed (RPM) in the power module. |
| 96 | READ_POUT | 2 | Word | R | This command shall return the calculated output being delivered by the power module, in Watts. (Divide value by 10) |
| 97 | READ_PIN | 2 | Word | R | This command shall return the calculated input being drawn by the power module, in Watts. (Divide value by 10) |
| 98 | PMBus™_REVISION | 1 | Byte | R | PMBus™ Revision |
| 99 | MFR_ID | 8 | Block | R | The command returns the ASCII string for manufacturer's ID. |
| 9A | MFR_MODEL | 12 | Block | R | The command returns the ASCII string manufacturer's model. |
| 9B | MFR_REVISION | 2 | Block | R | The command returns the ASCII string manufacturer's revision (example case "A0"). |
| 9C | MFR_LOCATION | 8 | Block | R | The command returns the ASCII string manufacturer's revision (example case "TORONTO"). |
| 9D | MFR_DATE | 4 | Block | R | The command returns the ASCII string manufacturer's date code (example case "0913"). |
| 9E | MFR_SERIAL | 8 | Block | R | The command returns manufacturers serial number. |

APPLICATION NOTES (CONTINUED)

PMBus™ Non-Standard Extended Command Subset

| Opcode (HEX) | Command Name | No. of Bytes | Type | Read / Write | Command Description |
|--------------|--------------------|--------------|-------|--------------|--|
| 16 | FIRMWARE_REVISION | 4 | Block | R | Read vendor specific firmware revision (ASCII string). Example case "A100" |
| 17 | BUILD | 4 | Block | R | Read vendor specific Build (ASCII string) |
| 20 | AUXILIARY_VOLTAGE | 2 | Word | R | Provides the measured output auxiliary voltage of the power module. (Divide decimal value by 100) |
| 8D | READ_TEMPERATURE_4 | 2 | Word | R | This command shall return a select component temperature used by the power module, in degrees Celsius. |
| 8E | READ_TEMPERATURE_5 | 2 | Word | R | This command shall return a select component temperature used by the power module, in degrees Celsius. |

Remote On/Off (PMBus™ Operation Command 0x01)

This command can be used to turn the unit on and off via the PMBus™ interface.

If D1 (REMOTE_ENABLE) is LOW (enabled) then the PMBus™ Remote On/Off function can turn the unit off and on. If D1 (REMOTE_ENABLE) is HIGH (disabled) then the PMBus™ Remote On/Off function cannot turn the unit on or off and can be ignored.

The bit encoding of the data byte of the command is as follows.

| Bits [7:6] | Bits [5:4] | Bits [3:2] | Bits [1:0] | Unit State |
|------------|------------|------------|------------|------------|
| 00 | XX | XX | XX | Off |
| 01 | XX | XX | XX | Off |
| 10 | 00 | XX | XX | On |
| 10 | 01 | 00 | XX | No change |
| 10 | 01 | 11 | XX | No change |
| 10 | 01 | 01 | XX | On |
| 10 | 01 | 10 | XX | On |
| 10 | 10 | 01 | XX | On |
| 10 | 10 | 10 | XX | On |
| 10 | 10 | 11 | XX | No change |
| 10 | 11 | XX | XX | No change |
| 11 | XX | XX | XX | No change |

DEMO BOARD

| Accessories | | |
|---------------------------------------|-----------------|------------------------------|
| Description | CUI Part Number | Vendor/Part Number |
| Demo Board ¹ | 01T-152501-1 | |
| DC Output Mating Connector | 22P-S00061-4 | FCI 51915-351LF |
| I ² C dongle ² | | Microchip DV164122 |
| Demo Board AC power cord ³ | | CNC Tech 800-12-32D-BL-0003F |

- Notes:
- This demo board is intended for user connection to evaluate the power supply in the laboratory by qualified personnel. Please take necessary safety precautions during product evaluation.
 - The PICKit Serial Analyzer is a USB-based tool used to direct communication between a PC and an external serial device. The kit comes complete with hardware (supporting I²C™, SMBus, SPI and USART protocols), an easy-to-use GUI (to configure and display communications) and a target demonstration board for out-of-the-box functionality. http://www.microchip.com/stellent/idcplg?IdcService=SS_GET_PAGE&nodeId=1406&dDocName=en028600
 - For North American use only

| Demo Board Power Connections | |
|------------------------------|-----------------------|
| J1 | +48V Output |
| J2 | 48V Return |
| J9 | + Standby Output |
| J8 | Standby Output Return |

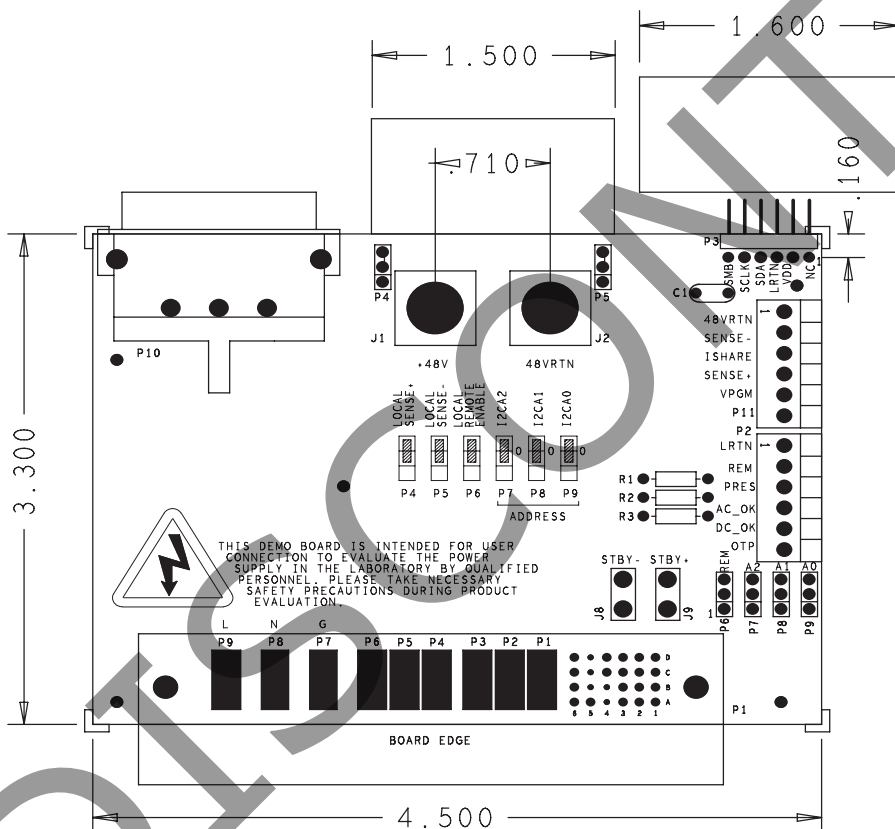

| Demo Board Connections/Settings | |
|---------------------------------|---|
| P1 | AC & DC Mating Connector |
| P2 | Control & Status Signals |
| 1 | Logical Return |
| 2 | Remote ON (override by P6) |
| 3 | Present |
| 4 | AC_OK |
| 5 | DC_OK |
| 6 | OTP |
| P3 | I ² C Dongle Connection |
| 1 | SMB |
| 2 | SCL |
| 3 | SDA |
| 4 | Logical Return |
| 5 | VDD |
| 6 | NC |
| P4 | Jumper to Local Sense+, remove jumper for remote sense |
| P5 | Jumper to Local Sense-, remove jumper for remote sense |
| P6 | Jumper to ON, remove jumper for Remote ON/OFF |
| P7 | Jumper to set I ² C A2 = 0, remove jumper to set address by host |
| P8 | Jumper to set I ² C A1 = 0, remove jumper to set address by host |
| P9 | Jumper to set I ² C A0 = 0, remove jumper to set address by host |
| P11 | Control & Status Signals |
| 1 | 48V Return |
| 2 | SENSE- (override by P5) |
| 3 | ISHARE (optional force sharing) |
| 4 | SENSE+ (override by P4) |
| 5 | Vpgm |
| 6 | NC |

POWER SHELF

| Power Shelf Model Number | Power Module Model Number | Airflow Direction | Shelf Power | | Standby Output | IEC Inlet Type |
|--------------------------|--------------------------------|-------------------|-------------|----------|--|----------------|
| | | | 110 Vin | 220 Vin | | |
| PPR-1U | PSE-3000-48-F or PSE-3000-54-F | Front to Back | 6,000 W | 12,000 W | All Parallel, dual polarity terminal block | C22 |
| PPR-1U-A | PSE-3000-48-F or PSE-3000-54-F | Front to Back | 6,000 W | 12,000 W | A & B Feed, dual polarity terminal block | C22 |
| PPR-1U-B | PSE-3000-48-B or PSE-3000-54-B | Back to Front | 5,400 W | 12,000 W | All Parallel, dual polarity terminal block | C20 |
| PPR-1U-C | PSE-3000-48-B or PSE-3000-54-B | Back to Front | 5,400 W | 12,000 W | A & B Feed, dual polarity terminal block | C20 |
| PPR-1U-D | PSE-3000-48-F or PSE-3000-54-F | Front to Back | 6,000 W | 12,000 W | All Parallel, single polarity terminal block | C22 |
| PPR-1U-E | PSE-3000-48-B or PSE-3000-54-B | Back to Front | 5,400 W | 12,000 W | All Parallel, single polarity terminal block | C20 |

PPR-1U, PPR-1U-A, PPR-1U-D - FRONT TO BACK AIRFLOW

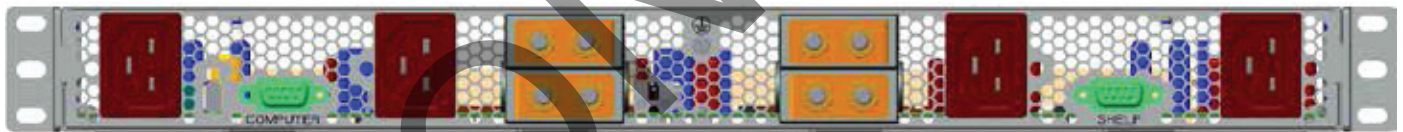

PPR-1U-B, PPR-1U-C, PPR-1U-E - BACK TO FRONT AIRFLOW



POWER SHELF (CONTINUED)

PPR-1U, PPR-1U-A, PPR-1U-D - FRONT TO BACK AIRFLOW

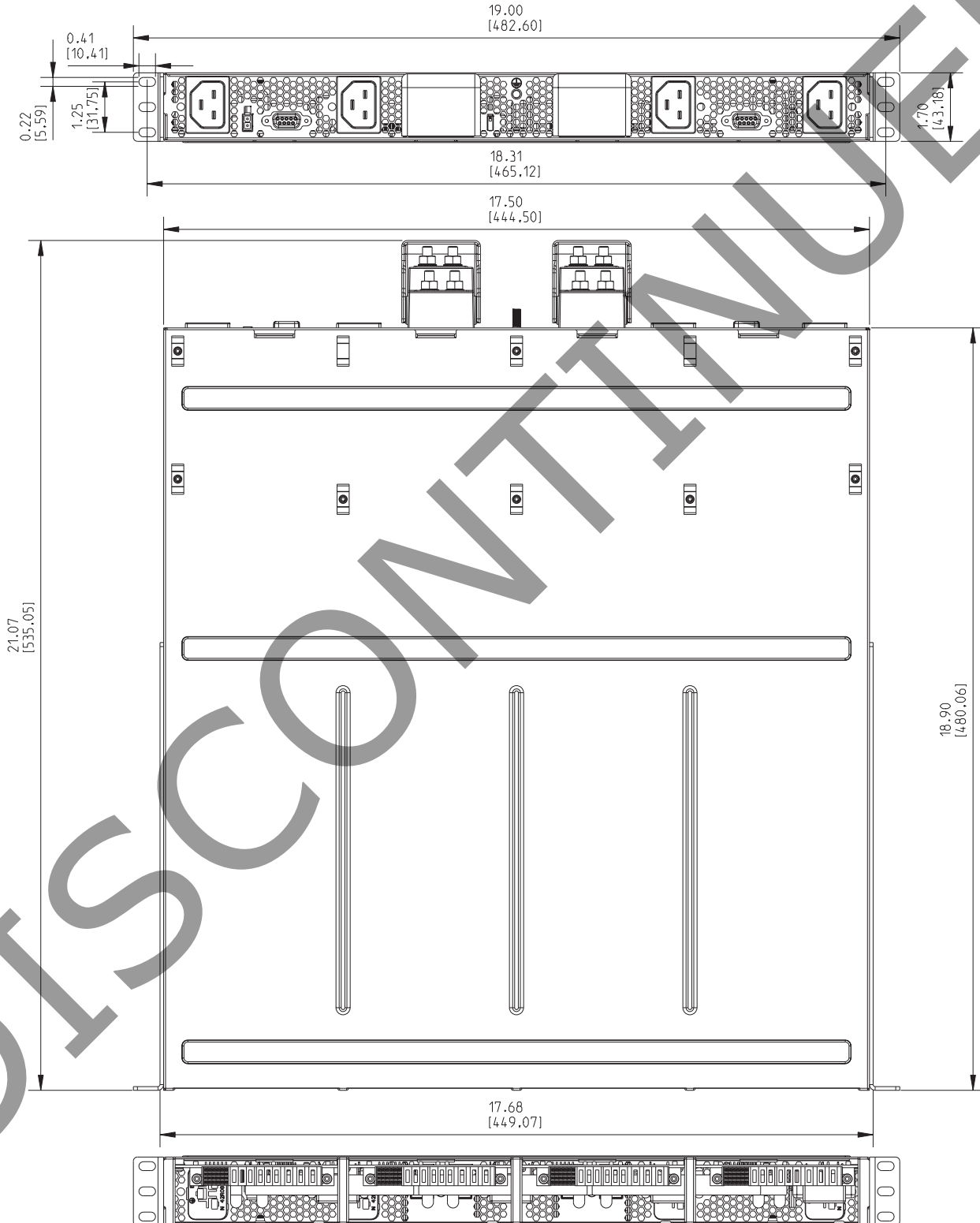

POWER SHELF (CONTINUED)

PPR-1U-B, PPR-1U-C, PPR-1U-E - BACK TO FRONT AIRFLOW

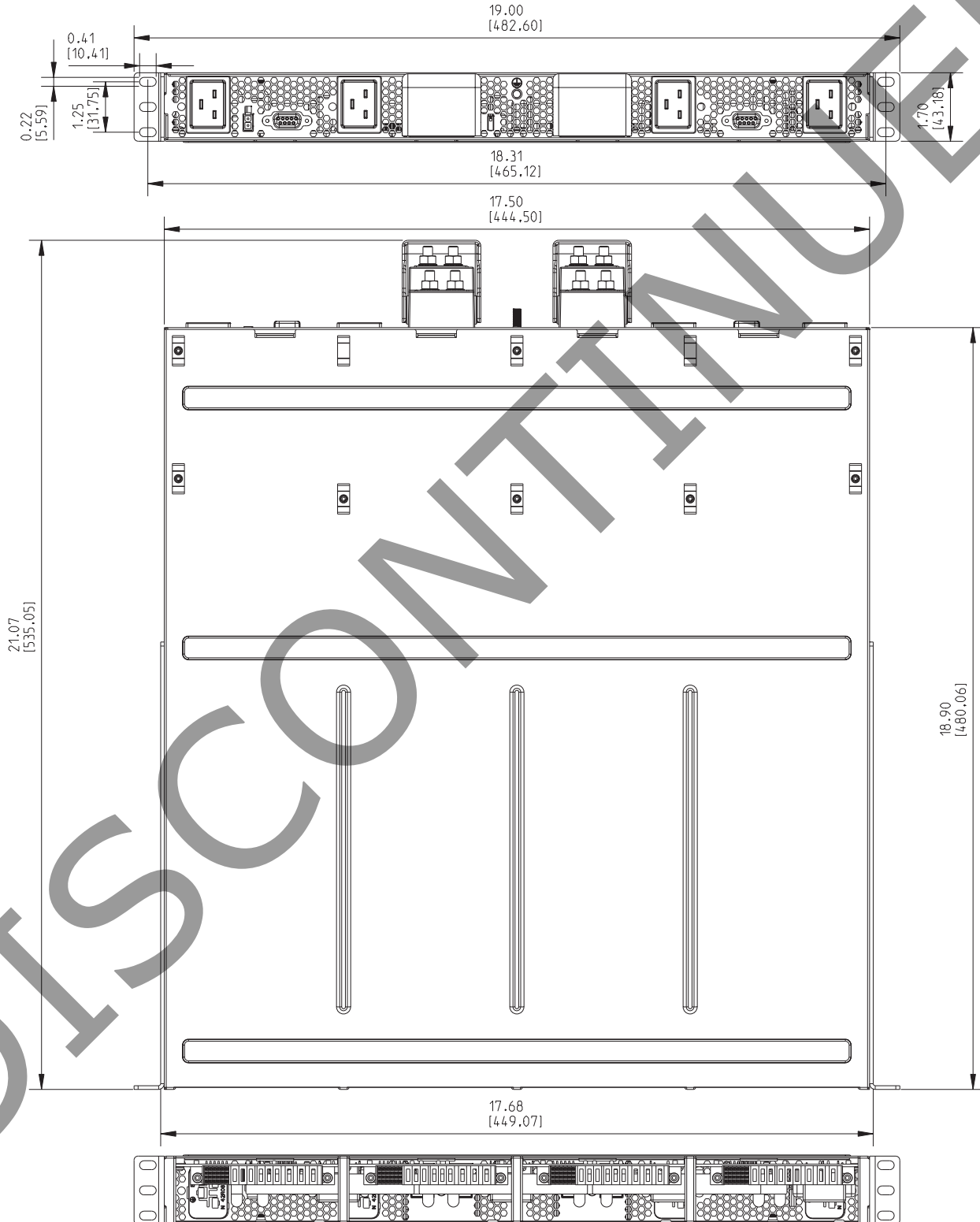

POWER SHELF (CONTINUED)

PPR-1U & PPR-1U-B Output Terminal Block Configuration

All 4 power modules wired in parallel inside the power shelf, 12 kW available from each output

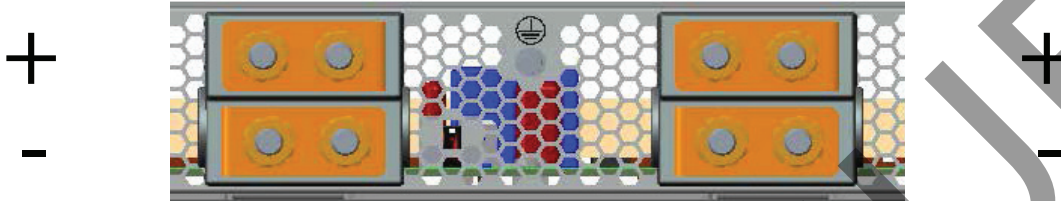

PPR-1U-A & PPR-1U-C Output Terminal Block Configuration

Each terminal block wired to 2 power modules, 6 kW available from each output

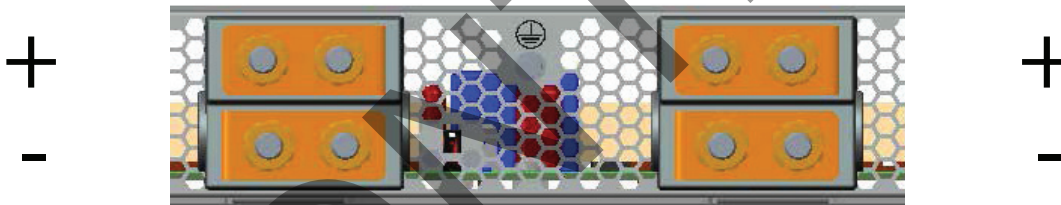

PPR-1U-D & PPR-1U-E Output Terminal Block Configuration

All 4 power modules wired in parallel inside the power shelf, one single output through both terminal block, 12 kW available from each output

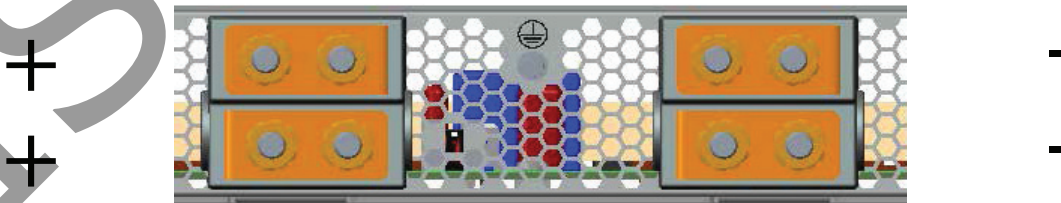

ASSEMBLY INSTRUCTIONS

Chassis Grounding

A ground stud is provided at the rear of the power shelf as shown below. Earth ground stud nut #10-32 to be torqued 16 to 19 in-lbs typical.

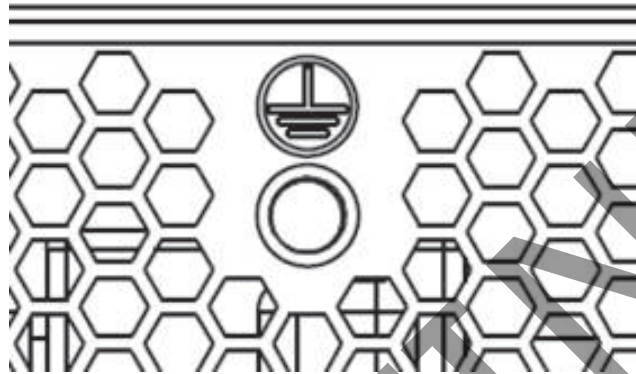

Bracket Attachment

The mounting brackets are factory attached in the flush position. The mounting brackets can be repositioned by customer, however the #6-32 mounting screws to be reattached with typical torque of 6 to 8 in-lbs.

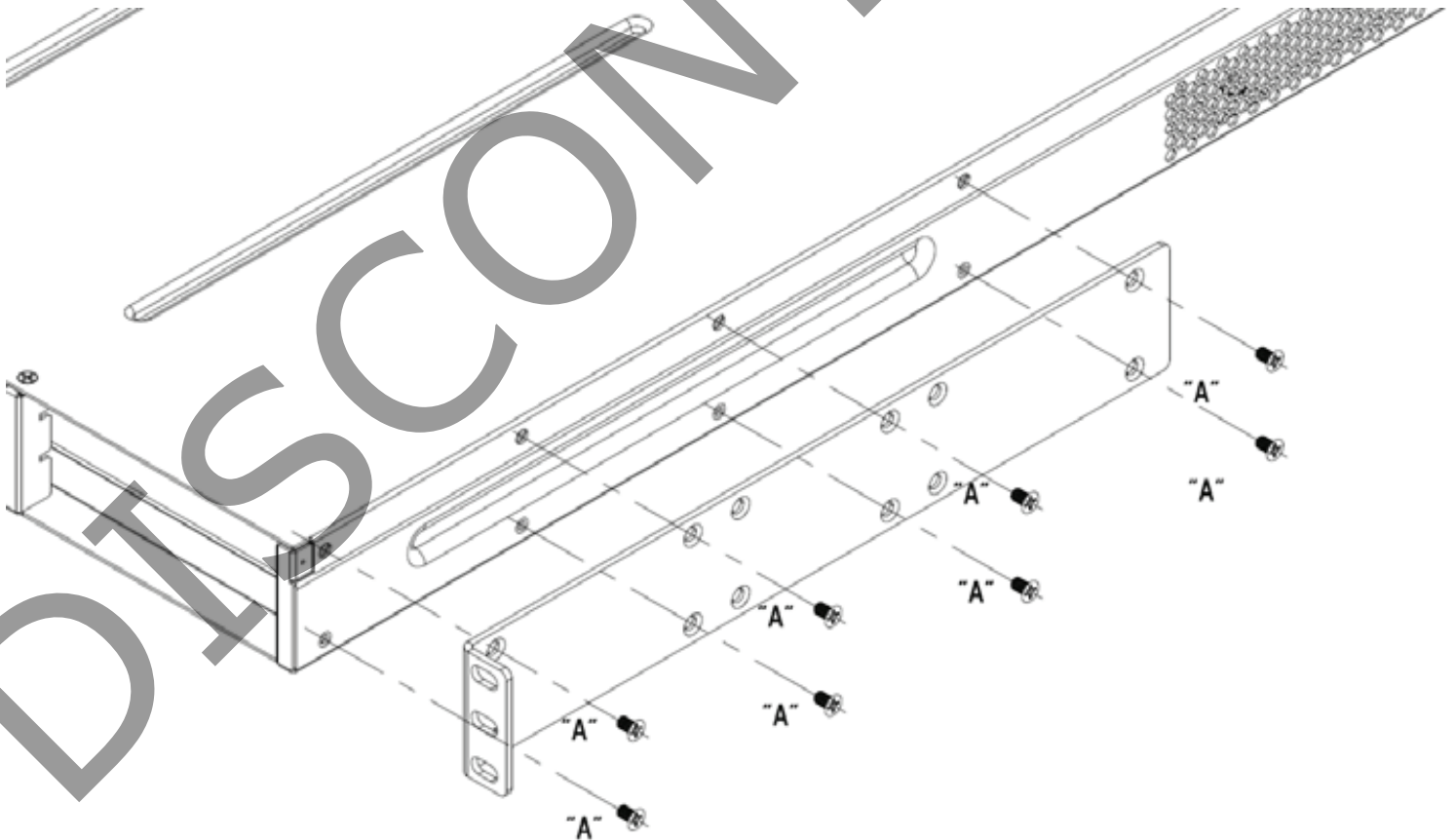

ASSEMBLY INSTRUCTIONS (CONTINUED)

Output Cable Connection

The Output and Return Cables (#2 AWG wire on 1/4" stud - not provided) to be A ground stud is provided at the rear of the power shelf as shown below.

Earth ground stud nut #10-32 to be torqued 16 to 19 in-lbs typical.

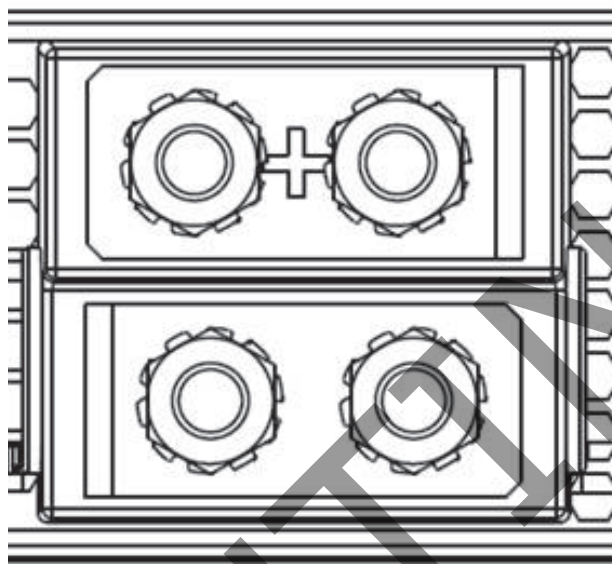

AC Line Cord Connection

The power shelf is not shipped with AC line cords and the customer is responsible to provide its own AC line cords to meet the respective local electrical code requirements.

ASSEMBLY INSTRUCTIONS (CONTINUED)

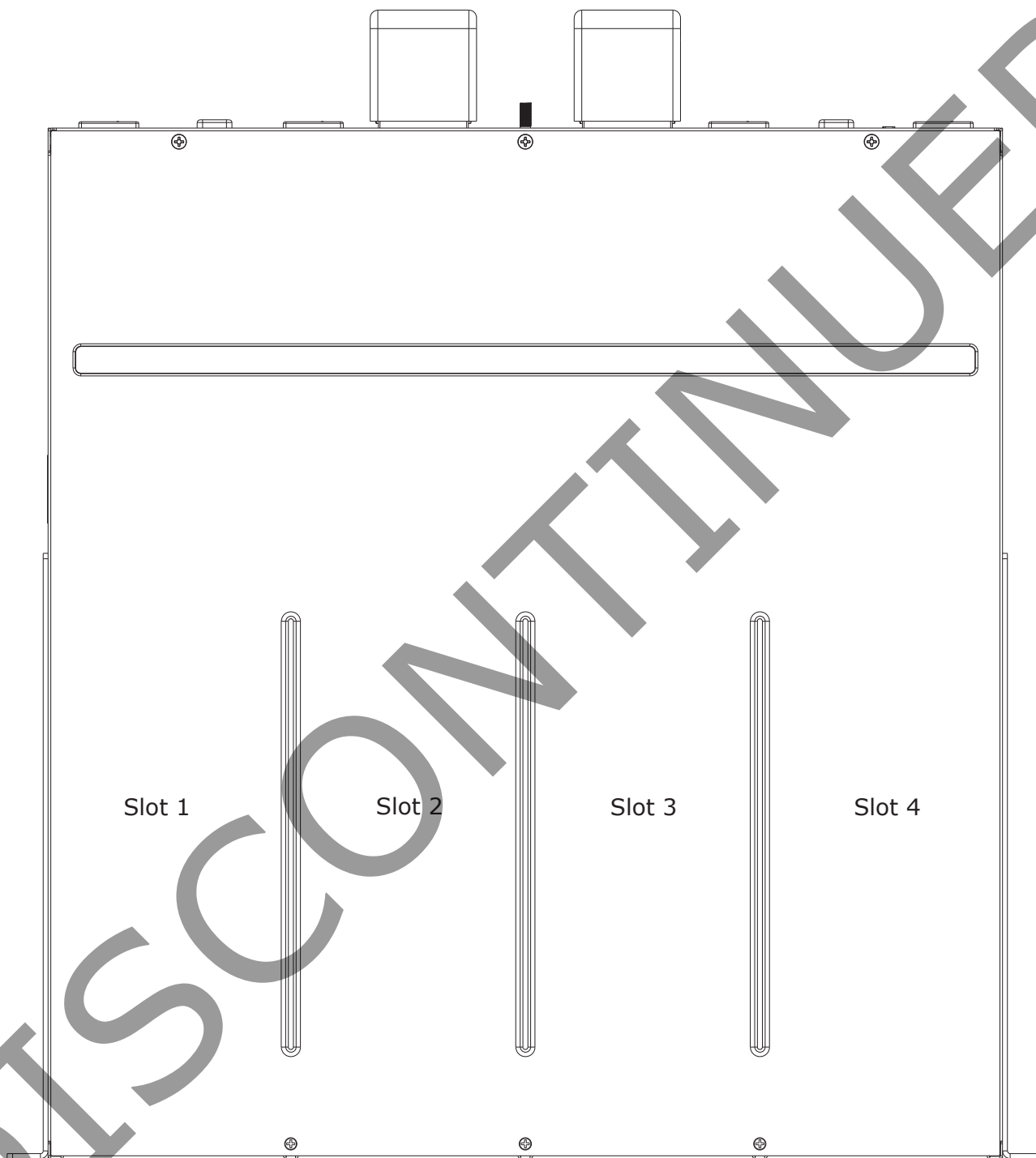

| A2 Address Switch | Address | | | |
|-------------------|---------|--------|--------|--------|
| | Slot 1 | Slot 2 | Slot 3 | Slot 4 |
| DOWN | 000 | 001 | 010 | 011 |
| UP | 100 | 101 | 110 | 111 |

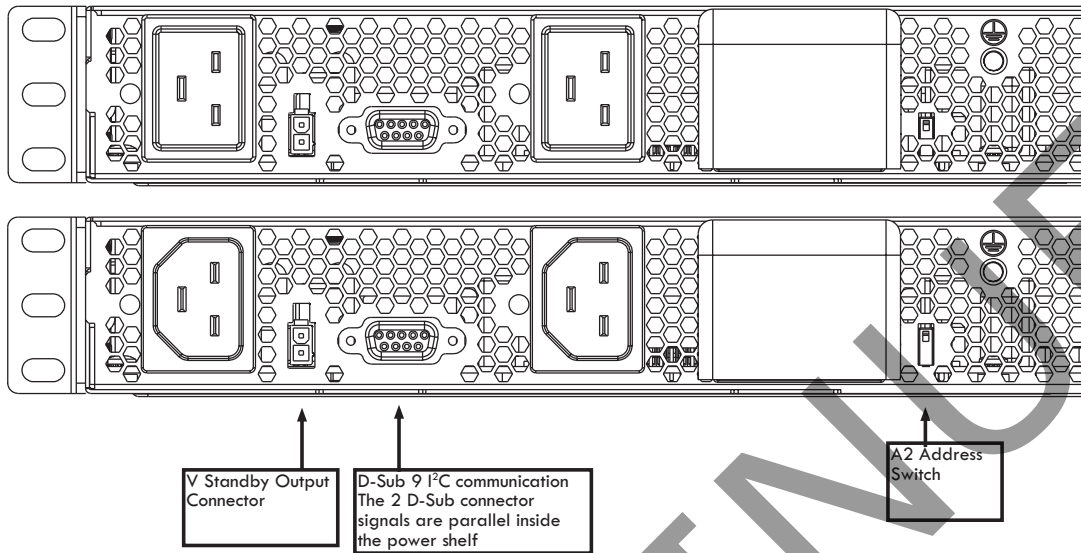
ASSEMBLY INSTRUCTIONS (CONTINUED)**V Standby Output Connector, Mating Connector Molex 39-01-2020, terminals 39-00-0038**

| Connector - Pin# | Signal Name | Function |
|--------------------|------------------|---------------------|
| 1 (lower position) | +3.3 STANDBY | +3.3 VDC +VE Output |
| 2 (upper position) | +3.3 STANDBY RTN | +3.3 VDC -VE Output |

| System Interface Connection | D sub 9 pin (female) | System to Shelf | Shelf to Shelf |
|-----------------------------|----------------------|-----------------|----------------|
| SDA | 1 | Yes | Yes |
| SCL | 2 | Yes | Yes |
| Not used | 3 | | |
| Vpgm | 4 | Yes | Yes |
| Vpgm Return | 5 | Yes | Yes |
| Digital Return | 6 | Yes | Yes |
| SMB Alert | 7 | Yes | Yes |
| Not used | 8 | | |
| I-Share | 9 | Yes | Yes |

A2 Address Switch, UP position for "1", DOWN position for "0"

| Accessories | | |
|--|-----------------|--------------------------------|
| Description | CUI Part Number | Vendor/Part Number |
| D-Sub 9 male to male cable | | Assmann WSW Components AK174-3 |
| Vstandby Output Mating Connector | | Molex 39-01-2020 |
| I ² C dongle ¹ | | Microchip DV164122 |
| I ² C dongle to D sub 9 cable | 014-157401-4 | |

Notes: 1. The PICKit Serial Analyzer is an USB-based tool used to direct communication between a PC and an external serial device. The kit comes complete with hardware (supporting I²C™, SMBus, SPI and USART protocols), an easy-to-use GUI (to configure and display communications) and a target demonstration board for out-of-the-box functionality.